

02 00  
02 01  
02 02  
02 03  
02 04  
02 05  
02 06  
02 07  
02 08  
02 09  
02 10  
02 11  
02 12  
02 13  
02 14  
02 15  
02 16  
02 17  
02 18  
02 19  
02 20  
02 21  
02 22  
02 23  
02 24

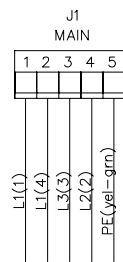

(1,2,3 or 4) - numbers marked on black wires

02 25  
02 26  
02 27  
02 28  
02 29  
02 30  
02 31  
02 32  
02 33  
02 34  
02 35  
02 36  
02 37  
02 38  
02 39  
02 40  
02 41  
02 42  
02 43  
02 44  
02 45  
02 46  
02 47  
02 48  
02 49

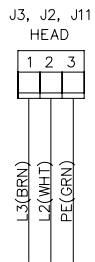
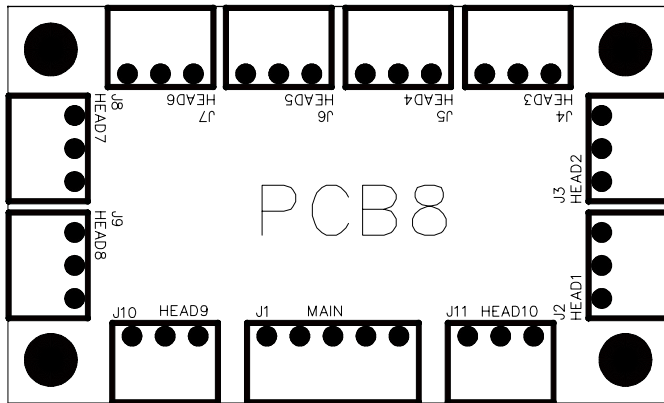
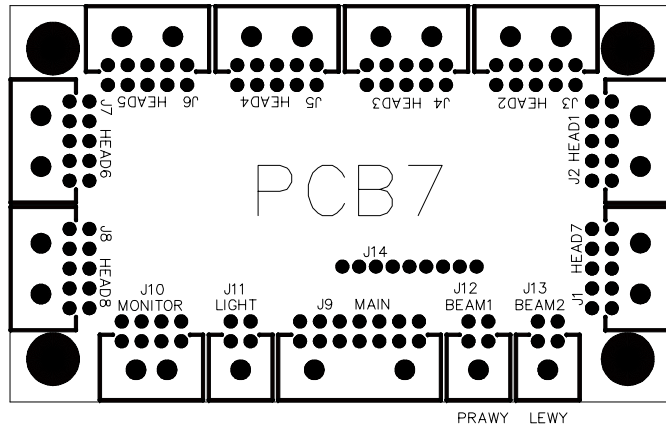
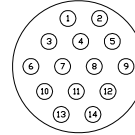
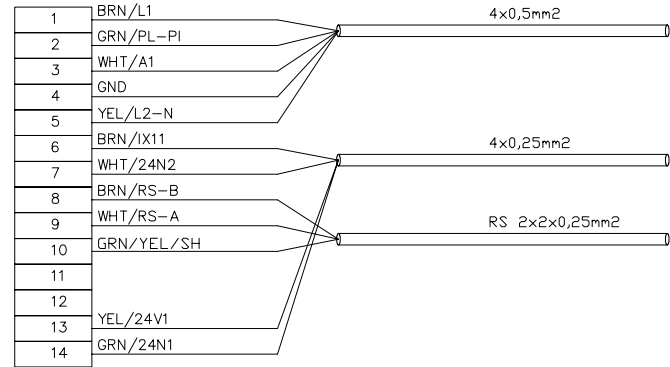
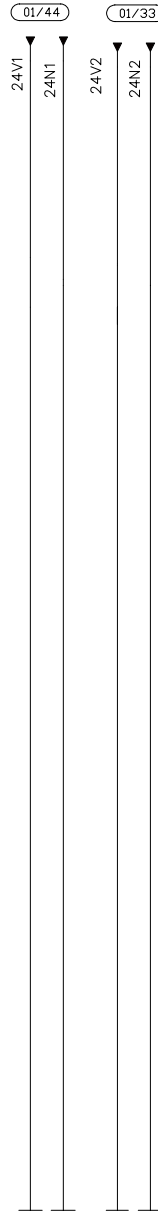

CONECTOR 230V MONITOR 6pin

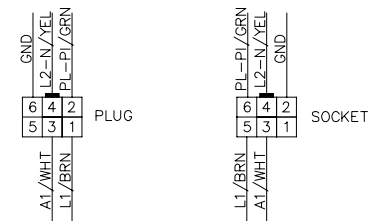

J9: 24V - 4x0,5mm2  
J9: IX, OX - 7x0,25mm2  
J9: RS - 2x2x0,25mm2

