

02 00
02 01
02 02
02 03
02 04
02 05
02 06
02 07
02 08
02 09
02 10
02 11
02 12
02 13
02 14
02 15
02 16
02 17
02 18
02 19
02 20
02 21
02 22
02 23
02 24

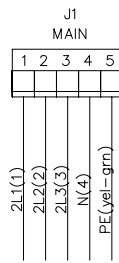

02 25
02 26
02 27
02 28
02 29
02 30
02 31
02 32
02 33
02 34
02 35
02 36
02 37
02 38
02 39
02 40
02 41
02 42
02 43
02 44
02 45
02 46
02 47
02 48
02 49

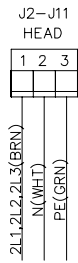
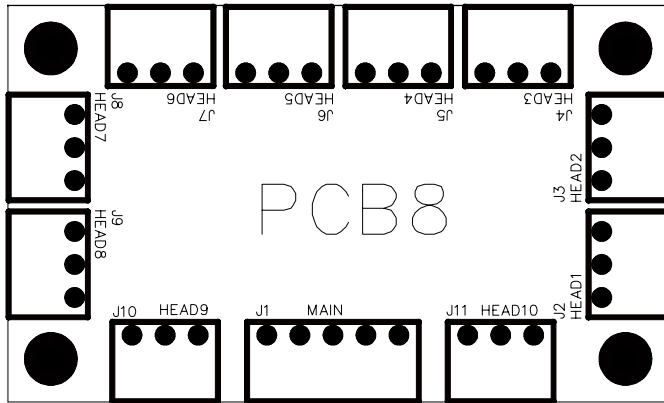
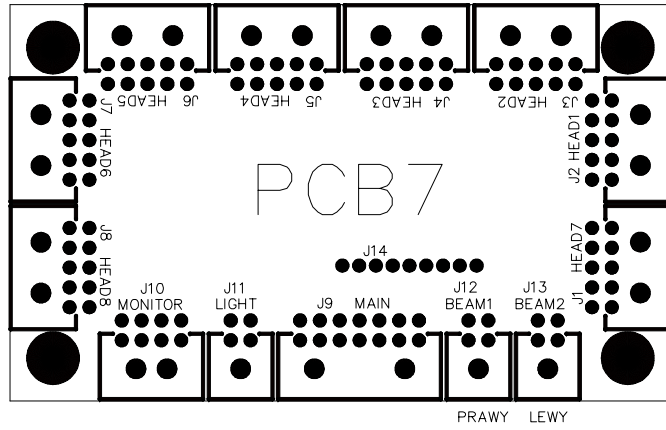
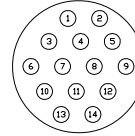
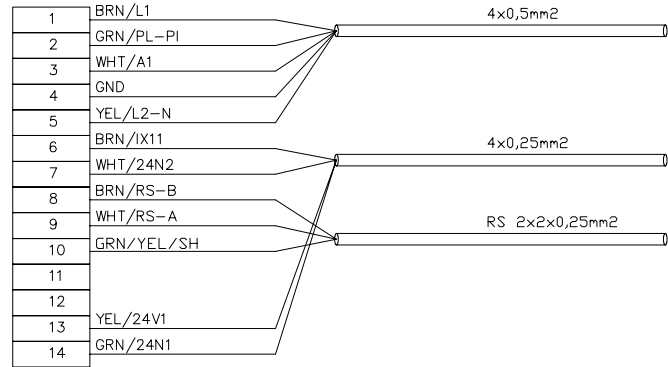
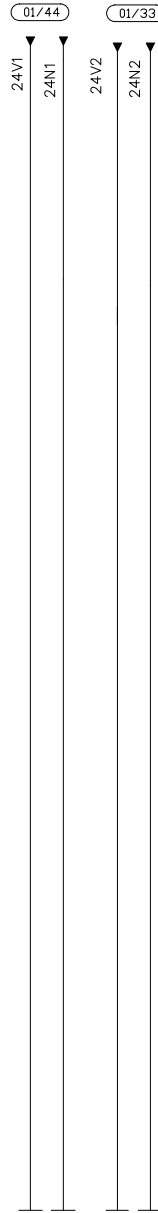

ZŁĄCZE 230V MONITOR 6pin

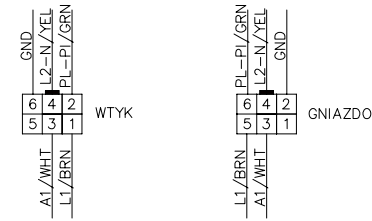

J9: 24V - 4x0,5mm2
J9: IX, OX - 7x0,25mm2
J9: RS - 2x2x0,25mm2

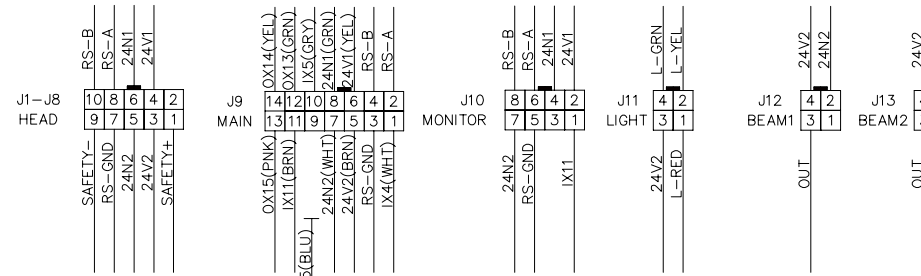

PRINTEX UE JOB NO. 1 DV

DR PM	CHK PM	APP PM	DATE 13
NAME NUOVO/SPECTRUM			
NAME POWER DISTRIBUTION			
SCALE B	PRO DWG2		